

MOVIMENTOS PRECURSORES

Uma abordagem do fim da Idade Média e do "Renascimento" da Humanidade



MOVIMENTOS PRECURSORES

ANÁLISE SÓCIO-POLÍTICA
ECONOMIA / PENSAMENTOS

Idade Média - Feudalismo Renascentismo Iluminismo

Por Marcio Martins Moreira



MOVIMENTOS PRECURSORES



ANÁLISE SÓCIO-POLÍTICA
ECONOMIA / PENSAMENTOS
FÉ / DOGMAS

Cristianismo Islã Protestantismo Renascentismo Iluminismo

Idade Média - Feudalismo

Por Marcio Martins Moreira

História – Linhas do Tempo



60 d.c. Início do Cristianismo

1614 Fama Fraternitates

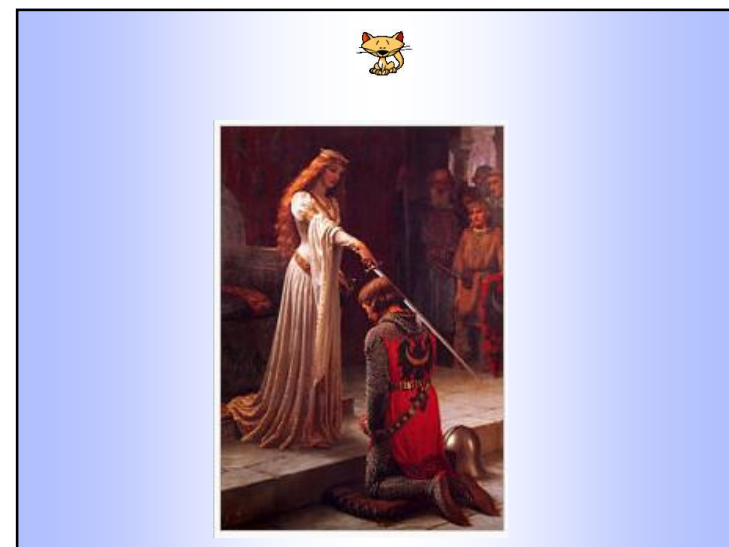
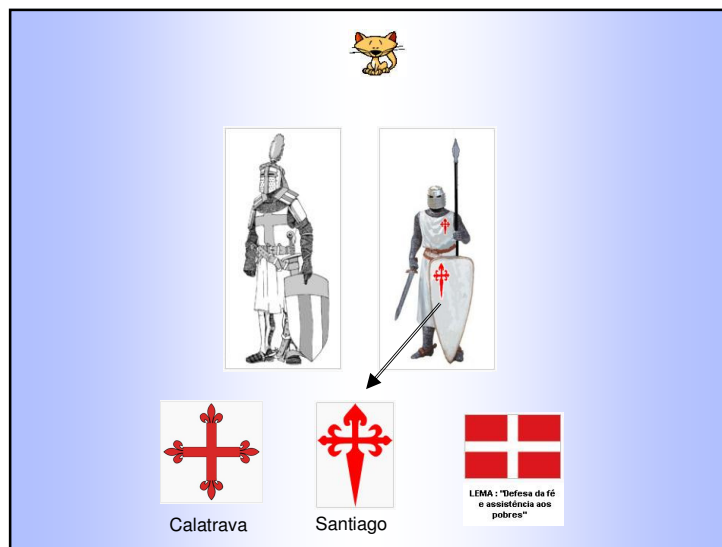
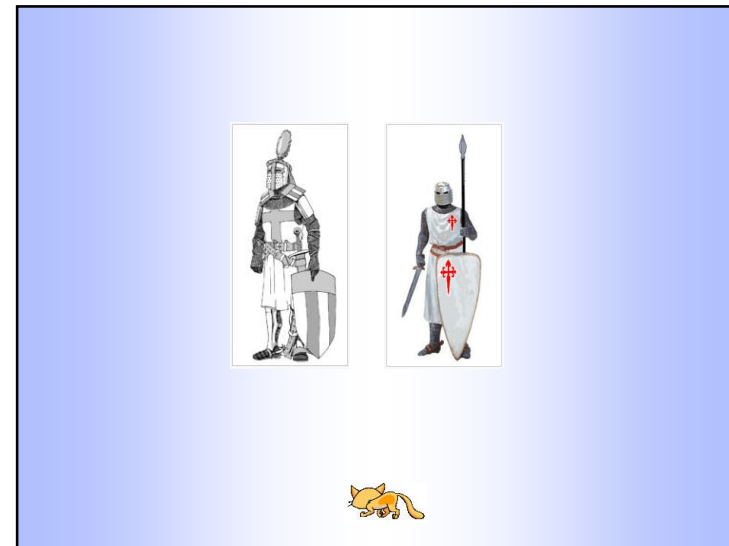
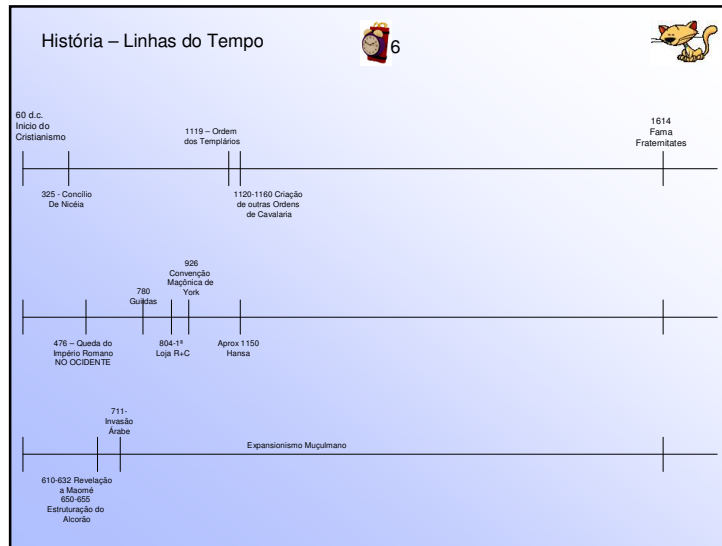

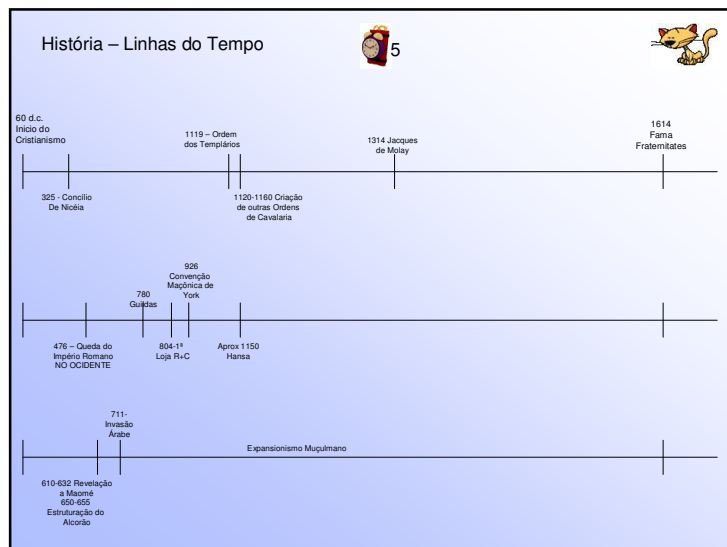

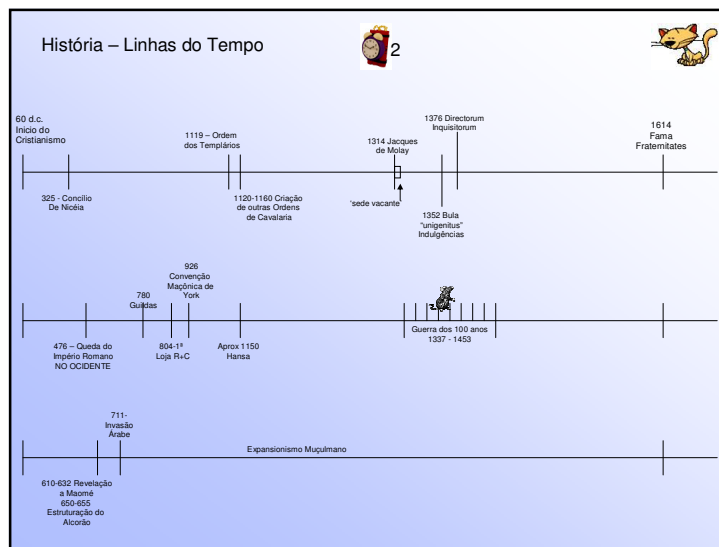
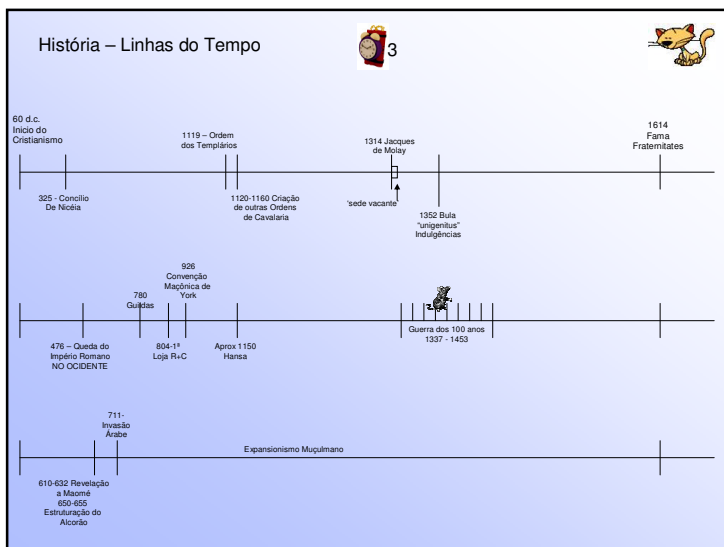
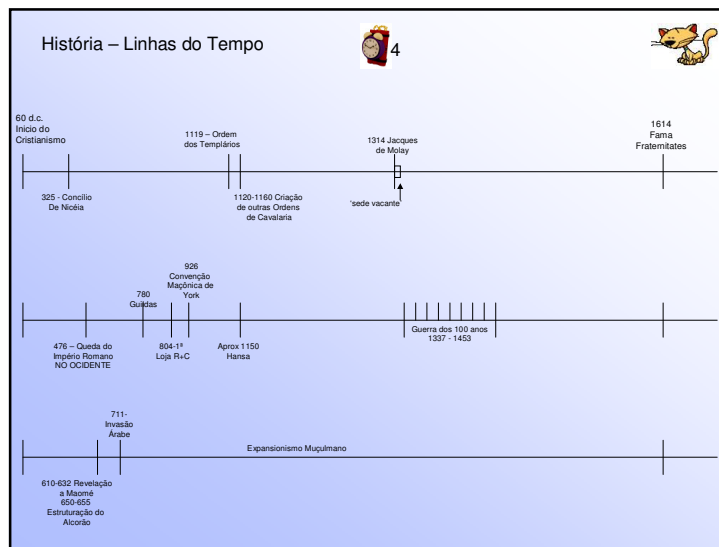

Directorum Inquisitorium

1376 compilado por Nicolau Eymerich
1578? Reformulado por Francisco de la Peña

Manual Operacional da Inquisição

1. O que é a fé?
2. Sobre a perversidade dos hereges
3. Sobre o ofício do Inquisidor



História – Linhas do Tempo

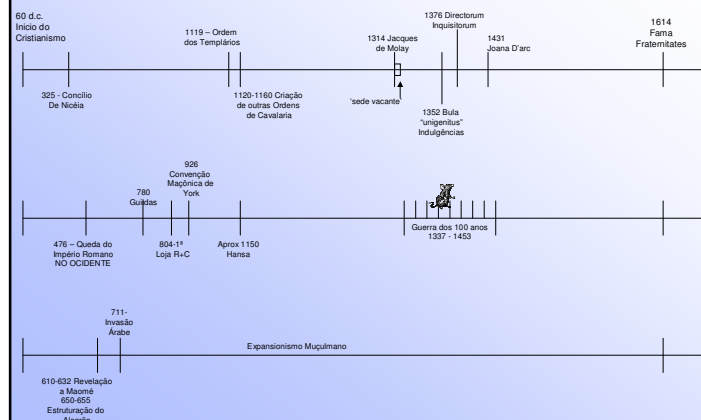

Joana D'arc – 1412-1431
Donzela de Orleans



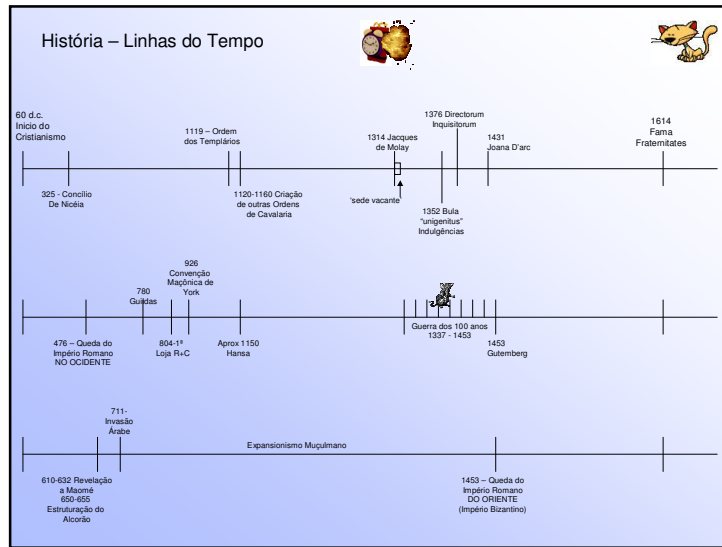

RENASCENTISMO

Antropocentrismo
Fim do Teocentrismo

Racionalismo
Razão/Matemática/Análise

Individualismo
Propriedade Privada
Limitação do Poder do Estado

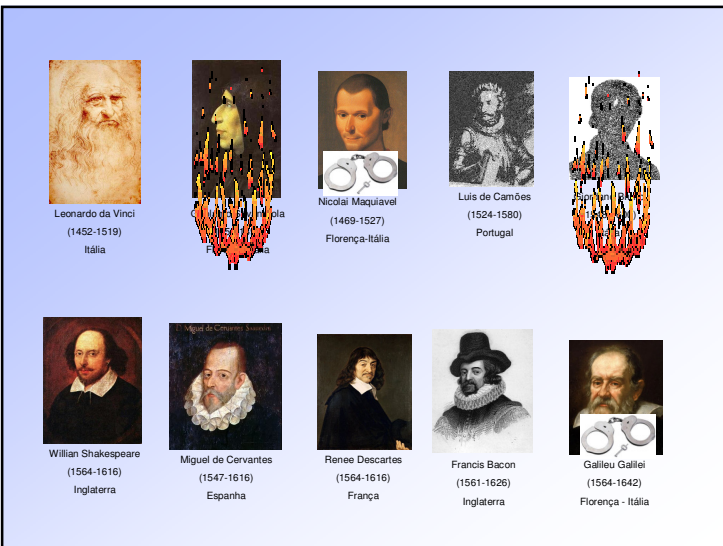

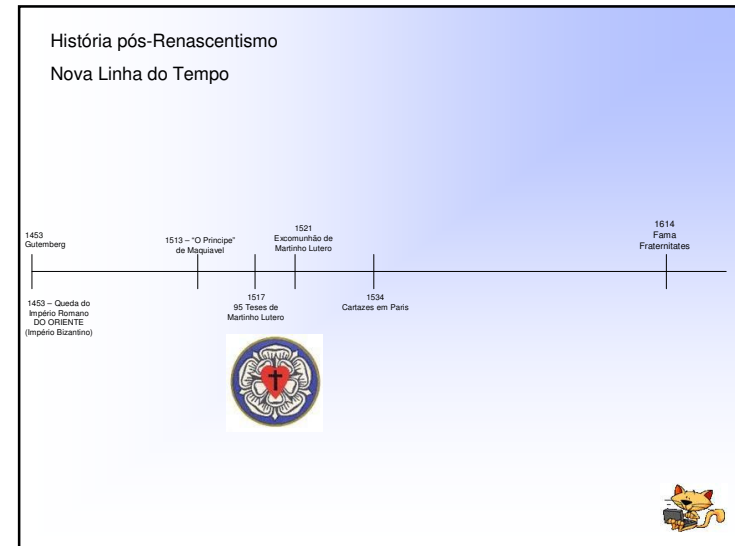
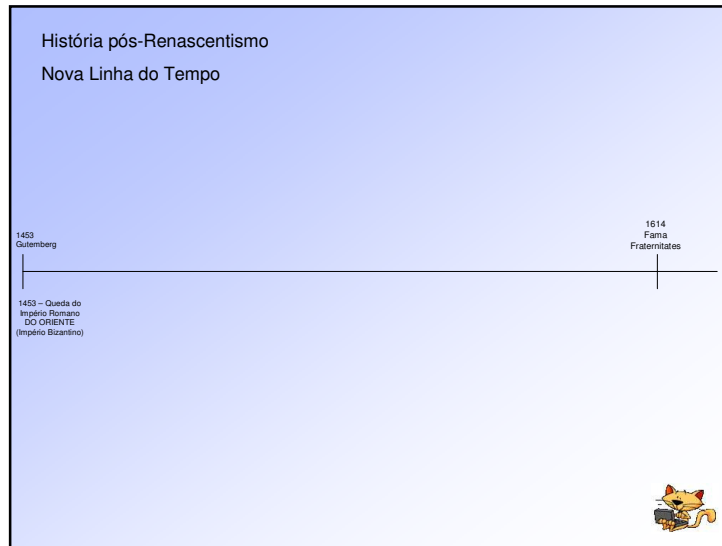

O que havia de novo ?

Linha	Onde	Novas Idéias	Idéias Antigas	Apoio de Quem
Luteranismo	Alemanha	Salvação do homem pelos atos praticados em vida e pela fé Era contra o culto de imagens e o celibato	Contra o Comércio	REIS / PRINCIPES
Calvinismo	França	Salvação através do trabalho justo e honesto Idéia do homem predestinado		Burguesia / Banqueiros / Trabalhadores Organizados
Anglicanismo	Inglaterra	Fim da subordinação direta ao papa		Inglaterra toda

Resumindo os fatores de mudança:

- Abusos de Poder da Igreja
- Mudança de Visão de Mundo
 - Pensamento Renascentista
 - Pensamento baseado na ciência
 - Homem quer ler mais, ter opinião própria
 - Busca da verdade através de experiências e da Razão
- Burguesia Indignada com os clérigos
 - Obter lucros era prática condenável pelos religiosos
- Interferência Papal nos assuntos dos reinos

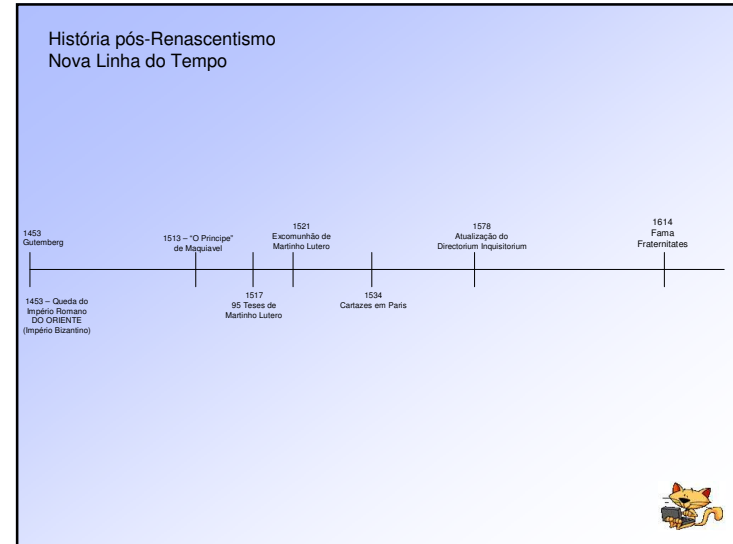

CONTRA-REFORMA

CONCÍLIO DE TRENTO 1545



Criação do Index Librorum Prohibitorum

Retomada do Tribunal do Santo Ofício (Inquisição)
Atualização do Directorum Inquisitorium



Catequização dos habitantes da "terras novas"
Através dos Jesuítas

